

APPLICATION DATA SHEET



ENVIROGRAF®

AP057-06-2014

Product Number: 57

FB70 Fire Barrier Curtain

All curtains are supplied with sufficient adhesive for the 50 mm overlap. The adhesive can be applied to one face and pressed together, although it is best to apply a small layer to each face and apply together, giving a much quicker hold. Just hold together for approximately 1 minute, to allow the adhesive to grip. 1 litre of Adhesive is sufficient for 50 metres of curtain.

Should the Curtain be installed in a windy area, Envirograf ST50 or ST75 Class 0 Adhesive Tape can be applied over the glued joint to hold it more securely while the Adhesive dries.

For fixing the top, bottom and ends of the Curtain: For timber supports use Envirograf FB/T Battens, fixed through to the timber with 30 mm large head clout nails. For concrete, block or brick fixing, use FB/C Metal Straps - 25 mm wide, with 2 mm holes every 300 mm apart. These can be fixed with spit nails, screws, pop rivets (steel) or self tapping screws to the steel work.

Where cutting around services is required;

1. Wrap around the service with a section of the curtain and adhere together using the adhesive.
2. Cut a cross – X – in the barrier to allow the service through. Once the service is wrapped, adhere the cut area of the curtain to the wrapped service.
3. If necessary, fit a patch over the curtain with the adhesive, using a section of curtain as the patch.
4. Where PVC pipes, cables, services, etc., pass through the curtain, we have attached a drawing showing the use of our FB/C Battens and our Economy Boxes (Picture 4 on the sheet).

FIXING INSTRUCTION – PITCHED ROOF

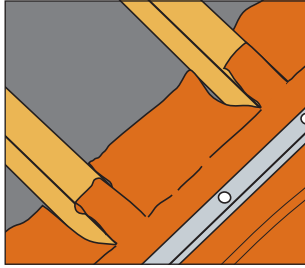

When the barrier overlaps felt battens, it is important to cut the barrier as shown above, tucking it between the battens

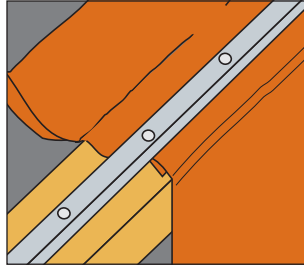

When the barrier overlaps a battenless roof, it is important that the barrier overlap is double-folded under the fire barrier fixing batten

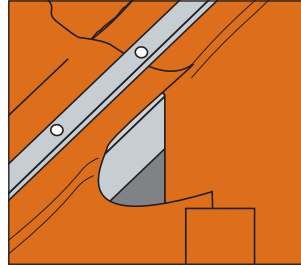

A 50mm overlap must be allowed at joints, for fixing with tape and supplied Envirograf® adhesive. Optional tape available for extra support during setting

FIXING INSTRUCTION – SUSPENDED CEILING

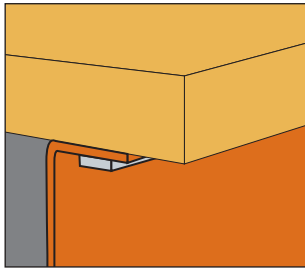

To fix the barrier to the upper roof section, use the metal strap to clamp the barrier and fix with screws or pins

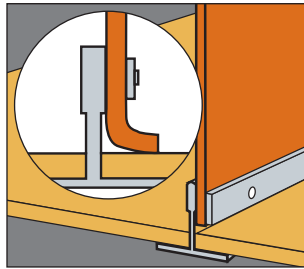

To fix the barrier to suspended ceiling brackets, either use the metal strap and self-tapping screws as shown above left, or the special clips shown above right, spaced at 500mm intervals

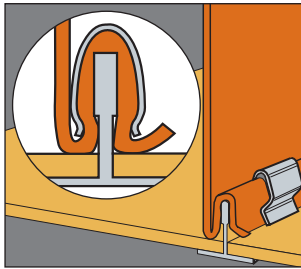

FIXING INSTRUCTION – SERVICE PENETRATIONS

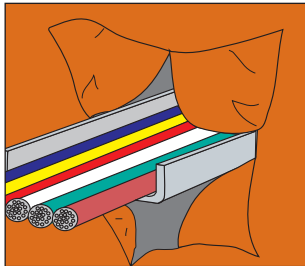

Cut a cross in the barrier to allow the service through

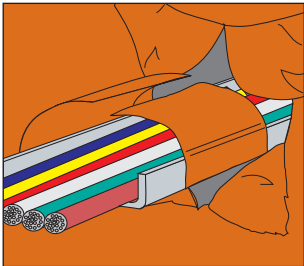

Wrap a 600mm wide barrier strip around the service, allowing 300mm width of cover on both sides of the position where the service penetrates the barrier

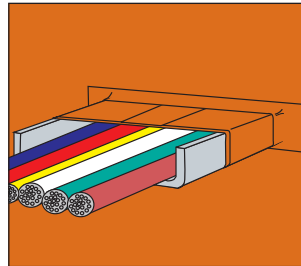

Tidily finish sealing the penetration with Envirograf® adhesive and tape as shown above

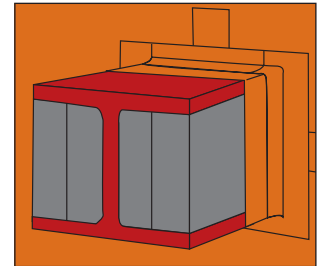

For RSJs and other steel sections, fill out with Envirograf® fireproof sponge as shown above, finishing with Envirograf® adhesive and tape

FIXING INSTRUCTION – DOOR

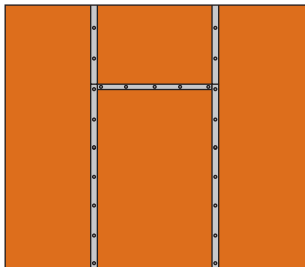

Mark out the door area as shown above and cut the opening edges. Sandwich the hinge side with two pieces of steel strap and rivet the strips together as shown.

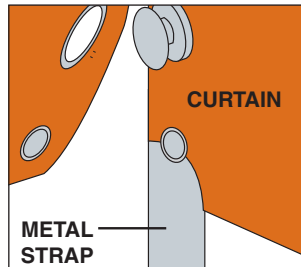
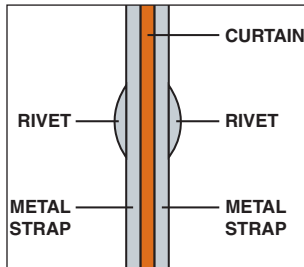

On closing edges of the frame side, rivet one section of steel strap and fix the special turn-button fixings as shown above

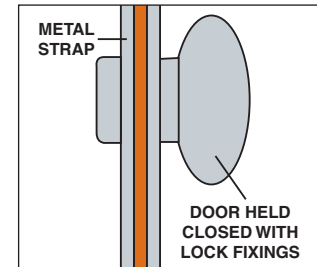

With the door section fixing rings fitted, the door shuts and is locked by turning the turn-button fixings

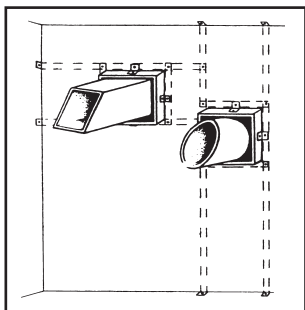

Penetrations through barriers (cable trays, pipes, timber beams, trunking, steel beams, etc) must be wrapped with a 600mm wide strip of the barrier, allowing 300mm width each side of the penetration, overlapping the strip ends by 50mm and adhering with Envirograf® Product 57 (FPA) adhesive. Where services are supported both sides of the barrier, no other protection is needed. If not supported both sides, or for PVC pipes or cables, then either Envirograf® Product 13 (WPCS) or Product 16 (EB) should be used with Product 57 (FB/C metal straps) as indicated in the drawing on the left

REGIONAL OFFICE